

TIRADOR + UÑERO

EMBUTIDA PARA PONER CON MOSQUITERO



Clave - 553035



Negro 493898	E-200	322377
Inox 323280	Blanco	312766

E-4	H	BE	CA	CH	CHD	CHMTY
N	B	ADK	E-5	E-1	E-2	W

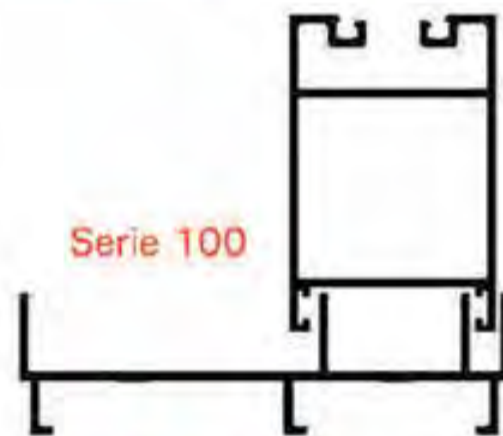

Serie 100

2 puntos

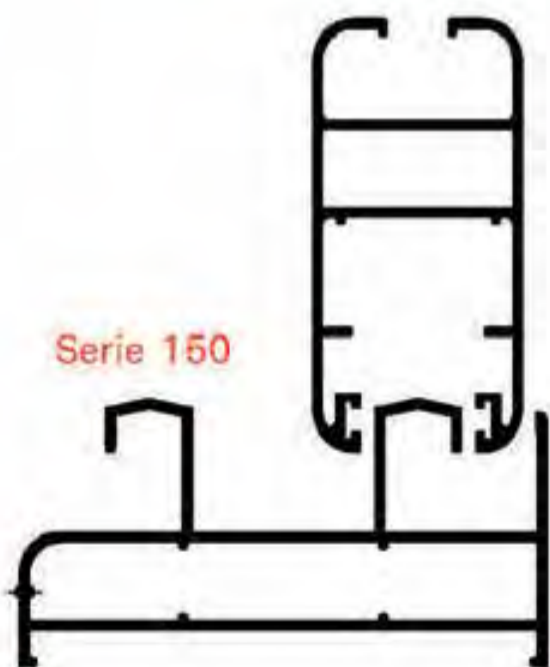

Serie 150

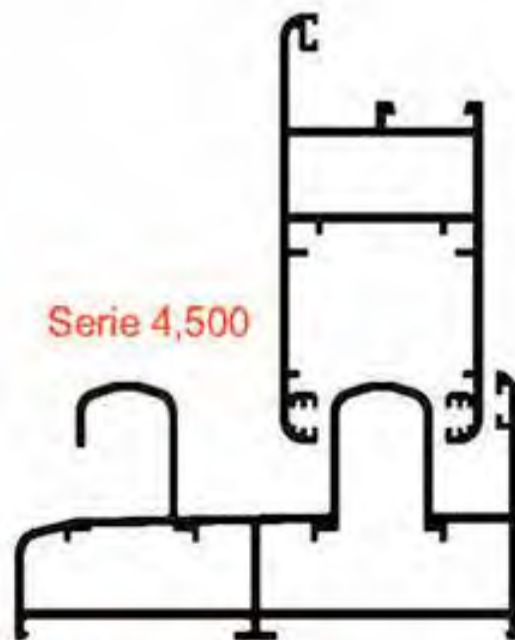

Serie 4,500

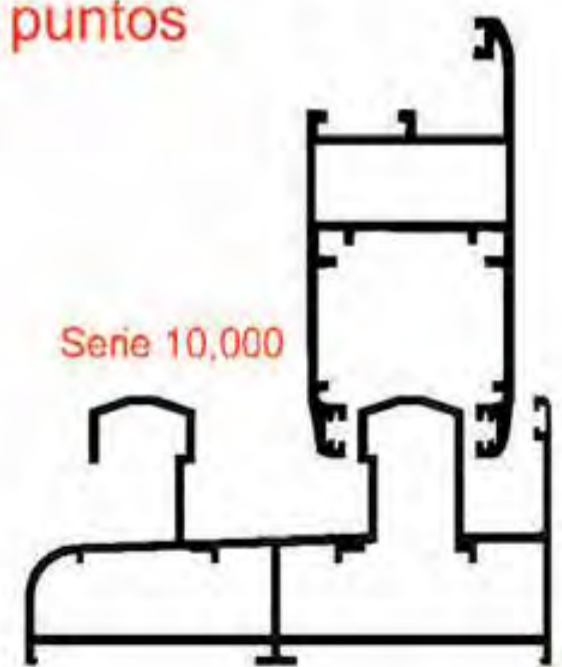

Serie 10,000

2 y 4 puntos

Contenido

Cierres Embutidos	
U-800 Uñero Universal	2
800 Europea	3
3" y 2"	4
2"	5
DUO	6
Accesorios Duo	7
Instalación Duo	7- 10
Multipuntos	
Cierre Multipunto	11
Kits Multipunto	12-15
Accesorios Multipunto	13
Manillas	15
Cierres Especiales	
Sobreponer	16
Seguridad	
Pasadores	17
Bloqueo traslape	18
Chapas	18
Barra de seguridad	19
California	23
Línea Caoba	24
Plásticos	
Candados - Sellos - Drenes	20
Escuadras	
Escuadras	21
Kits	
Plásticos	22
Carretillas	
Importadas - Nacionales	23

ACABADOS EN ALUMINIO



ACABADOS EN ZAMAC

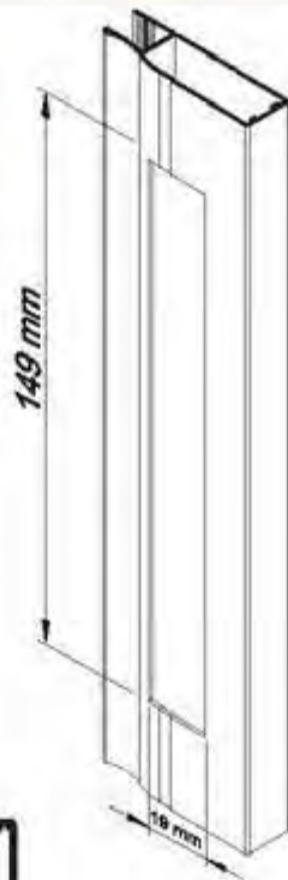

Olvídese de las trompas de elefante y las contra planas.

Nuevo Uñero en Nylon

- Mas elegante
- Mejor presentación
- Fácil instalación

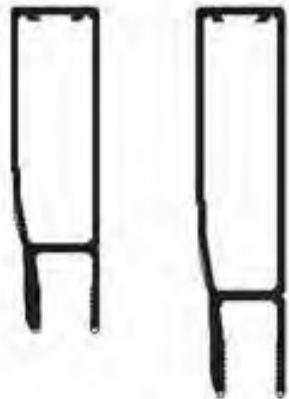

Canceles de Baño

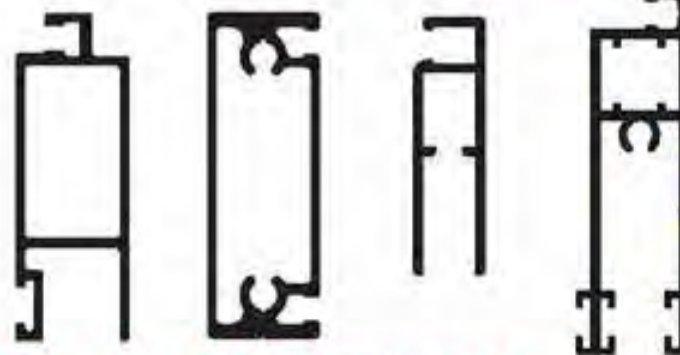

Mosquiteros



Colores



800 EUROPEA

Resaque



Nuevo Único

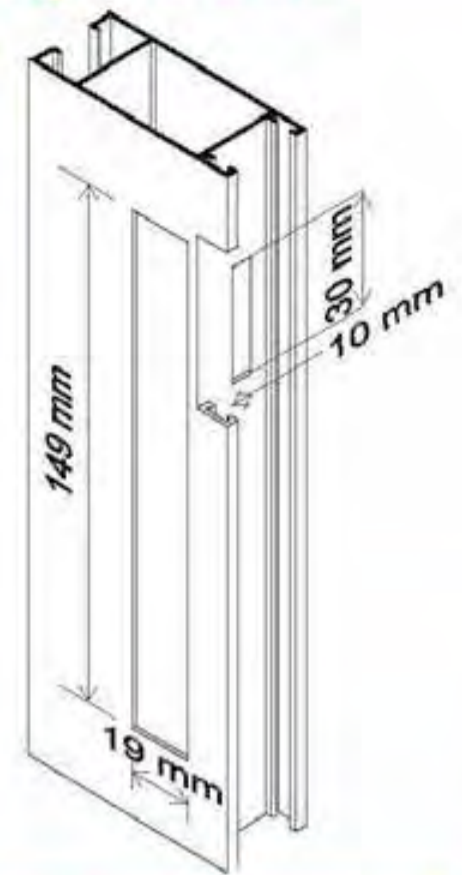

N	NB	O	B	BB	ADK	E-5	E-1	E-2	W	E-4	H	BE	CA	CH	CHD	CHMTY
---	----	---	---	----	-----	-----	-----	-----	---	-----	---	----	----	----	-----	-------

CUPRUM

S-3"

Serie 50

S-100

Serie 60 y 80

Serie 70

PROFILO Serie Ragazza

EXTRUSIONES METALICAS Serie 3,500

EUROAL-PROFILO

Serie Finestra

INDALUM

Serie 4000

Serie 4600



132 mm

Uñero de Embutir
Tipo Español
de Aluminio
Clave-1006



132 mm

Uñero de Sobreponer
Tipo Español
de Aluminio
Clave-1008



162 mm

Jaladera Tirador de
Aluminio Sólido de
Una Sola Pieza
Clave-1021



162 mm

Uñero de Embutir
Clave-1009

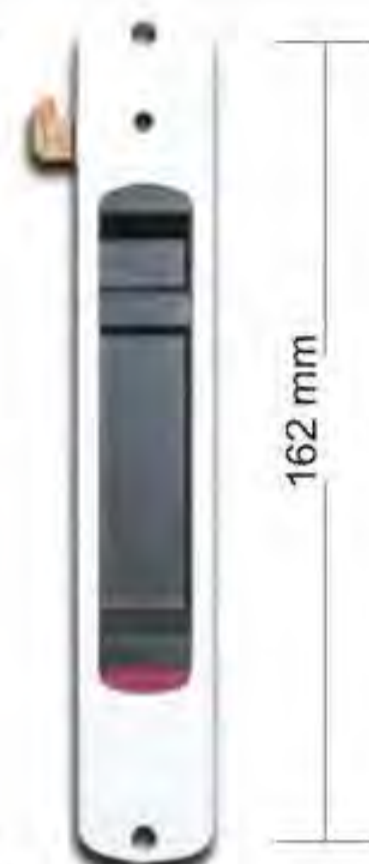

162 mm

Jaladera de Embutir
Manual y Automática
Clave-1001 y 1002

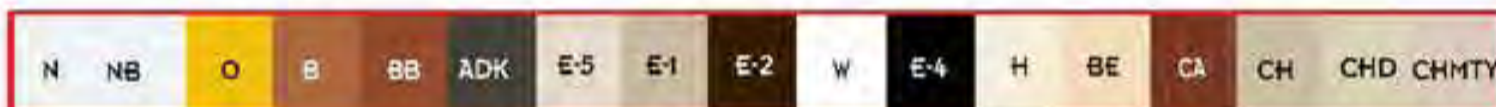

Uñero tipo
Español

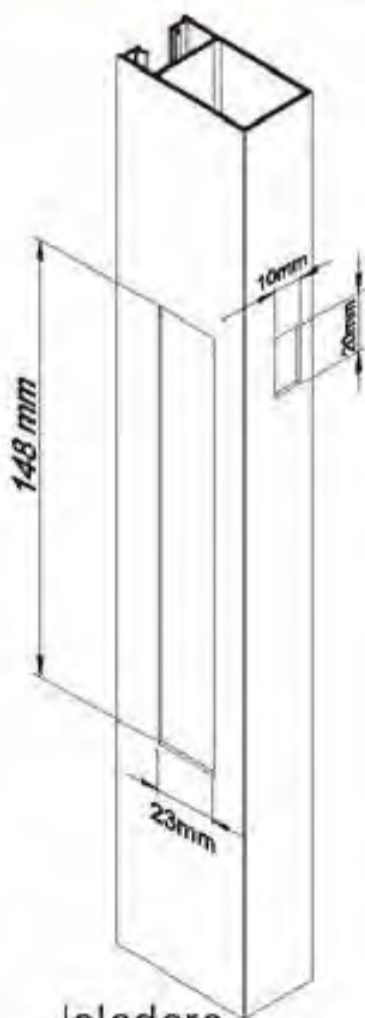

Jaladera
y Uñero

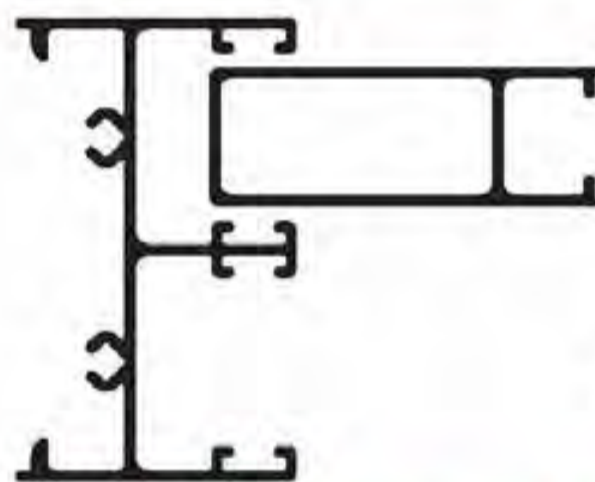

**Líneas aplicables
para 2" y 3"**





132 mm

Uñero de Embutir
Tipo Español
de Aluminio
Clave-1006



132 mm

Uñero de Sobreponer
Tipo Español
de Aluminio
Clave-1008



162 mm

Jaladera Tirador de
Aluminio Sólido de
Una Sola Pieza
Clave-1021



162 mm

Jaladera de Embutir 2"
Automática y Manual
Clave-2011-A y 2011-M

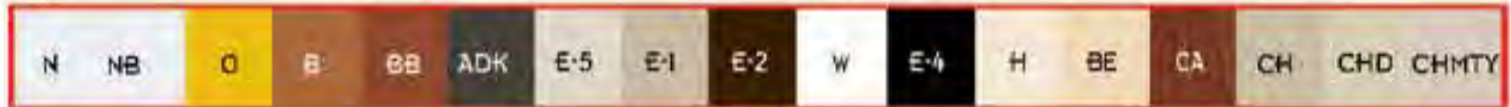

Uñero tipo
Español

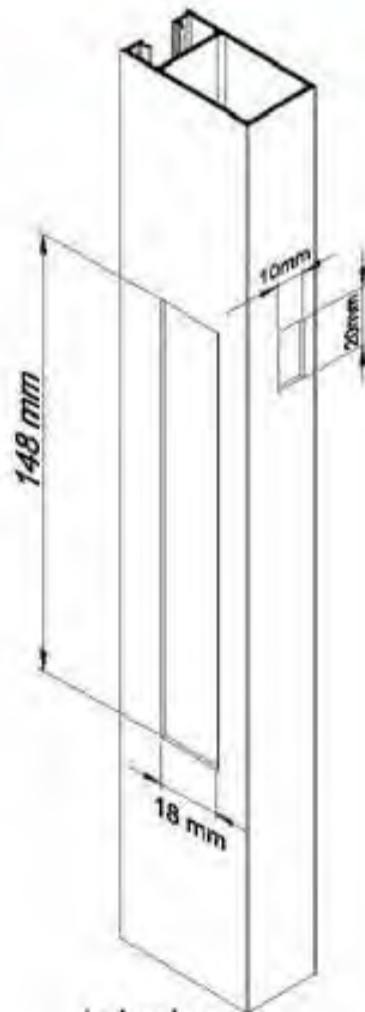

Jaladera

**Líneas aplicables
para 2"**

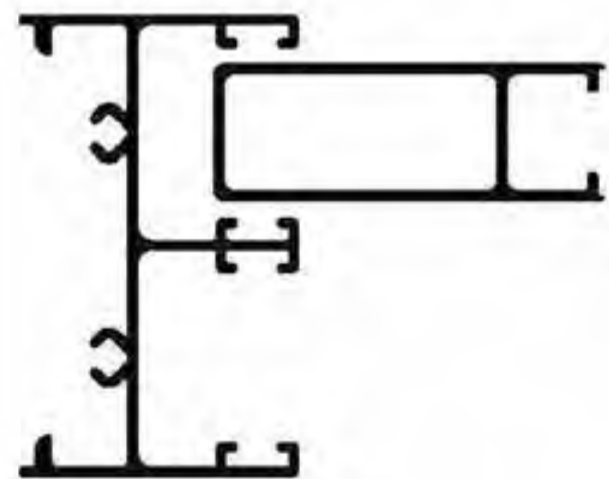

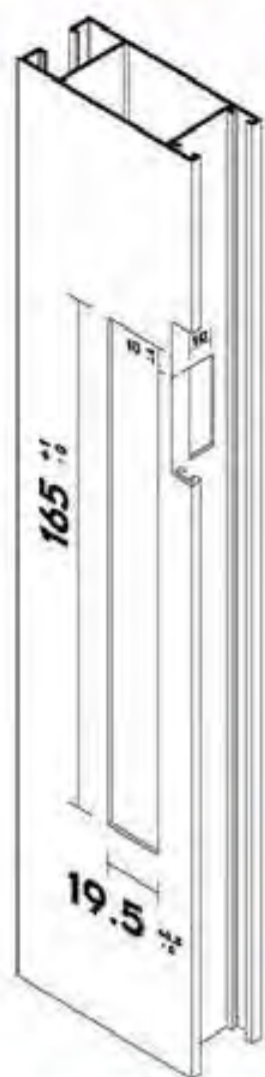

30



Tirador DUO

218 mm



Uñero DUO



Cierre DUO C/ llave



Cierre DUO

Negro	449975	449977	449929	386894
Plata	470047	449978	449932	387095
E-200	470048	449979	449933	387096
Blanco	449976	449980	449934	387097

Todas las medidas en mm

CUPRUM

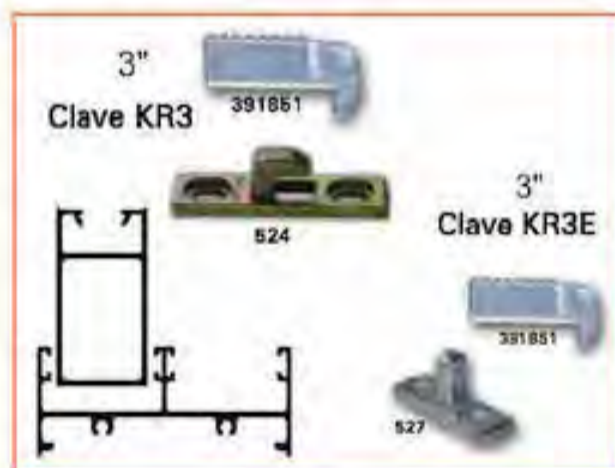

CUPRUM

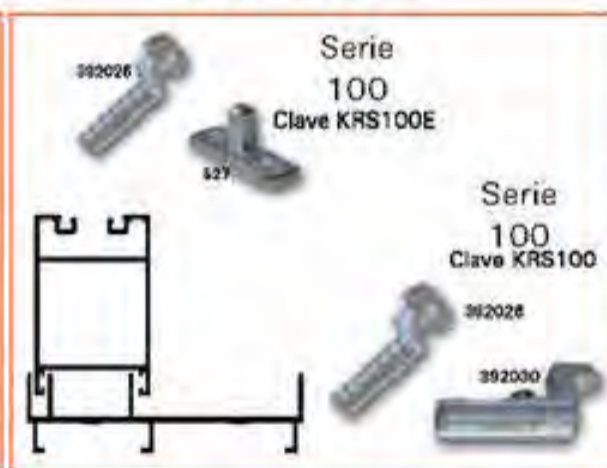

EUROAL-PROFILO



PROFILO



EXTRUSIONES METÁLICAS



INDALUM

Remachadora
Para Tuerca
Clave
RDACN-13



Plantilla Para
Montaje Tirador

Clave 470386



Remache Tuerca
Clave 377469
(sin tornillo)



Broca para
Tirador
Clave- Broca932



Remachadora
Para Tuerca
Black and Decker
Clave
RDABDK



Plantilla Para
Montaje Contra

Clave 446595



Llave Allen con
Mango de Plástico
2 mm.
Clave 377469



Llave Allen con
Mango de Plástico
2.5 mm.
Clave 377469



Llave Allen con
Mango de Plástico
3.0 mm.
Clave 377469



Llave Allen con
Mango de Plástico
4.0 mm.
Clave 377469



Instalación

- Cierre Duo estándar ó con llave

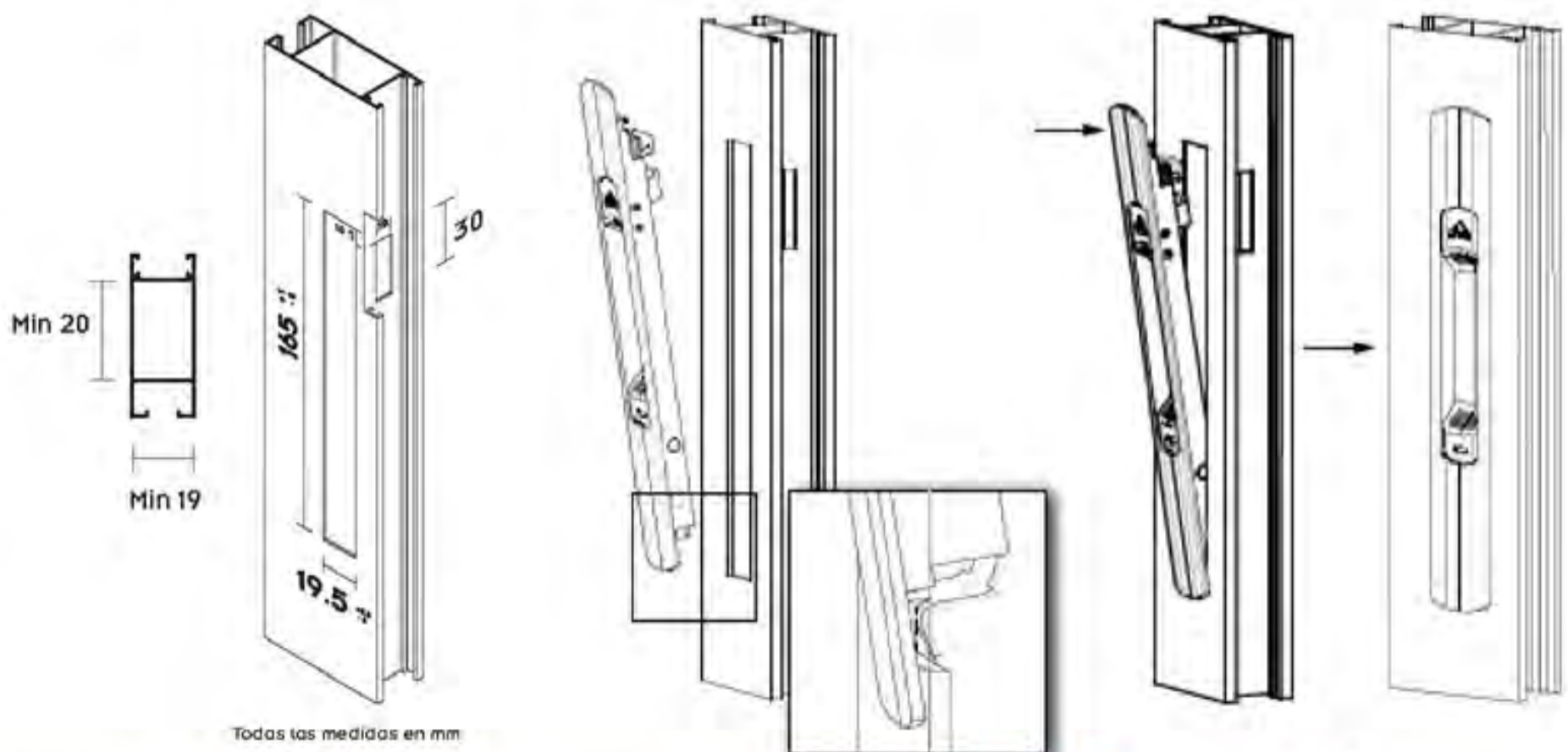

- Instalación Contra



Gancho Perimetral (S-60 y 80)



Gancho Tradicional



- Ajuste de Gancho

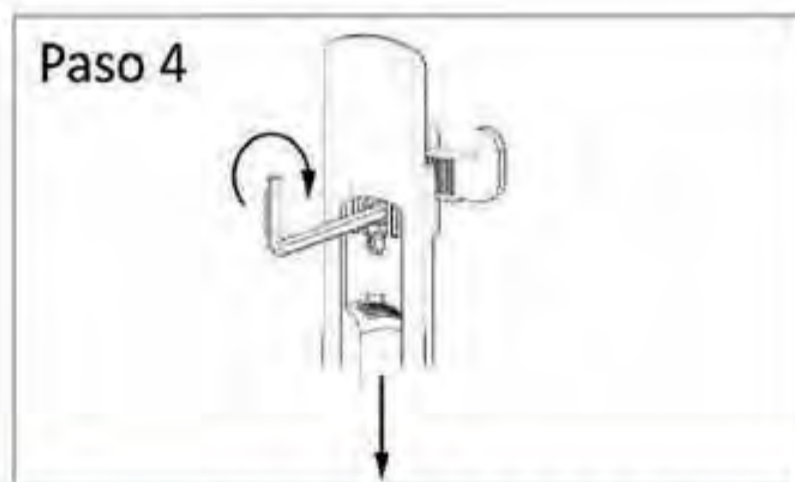
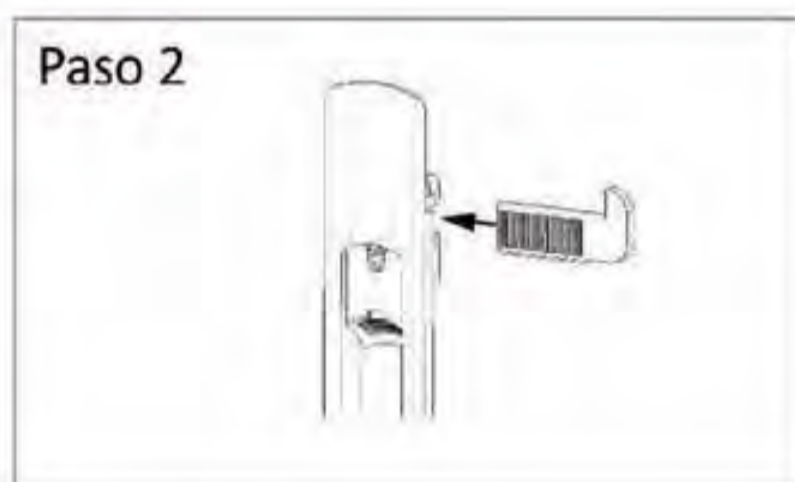
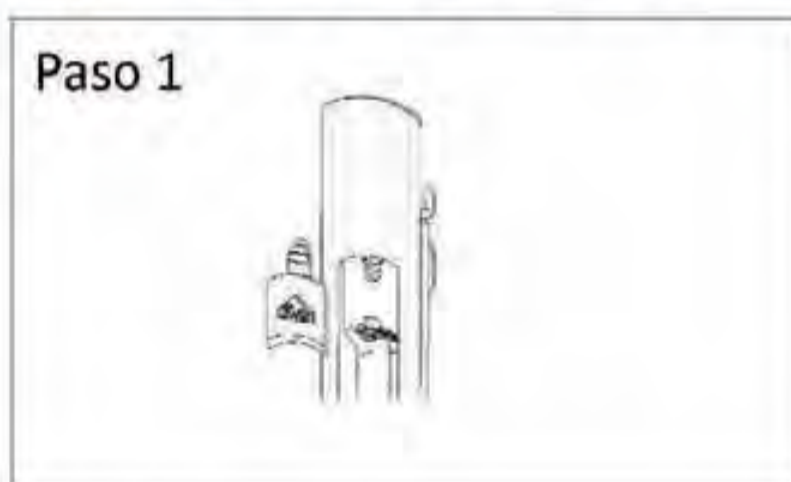

- Conversión de automático a manual en cierre estándar DUO

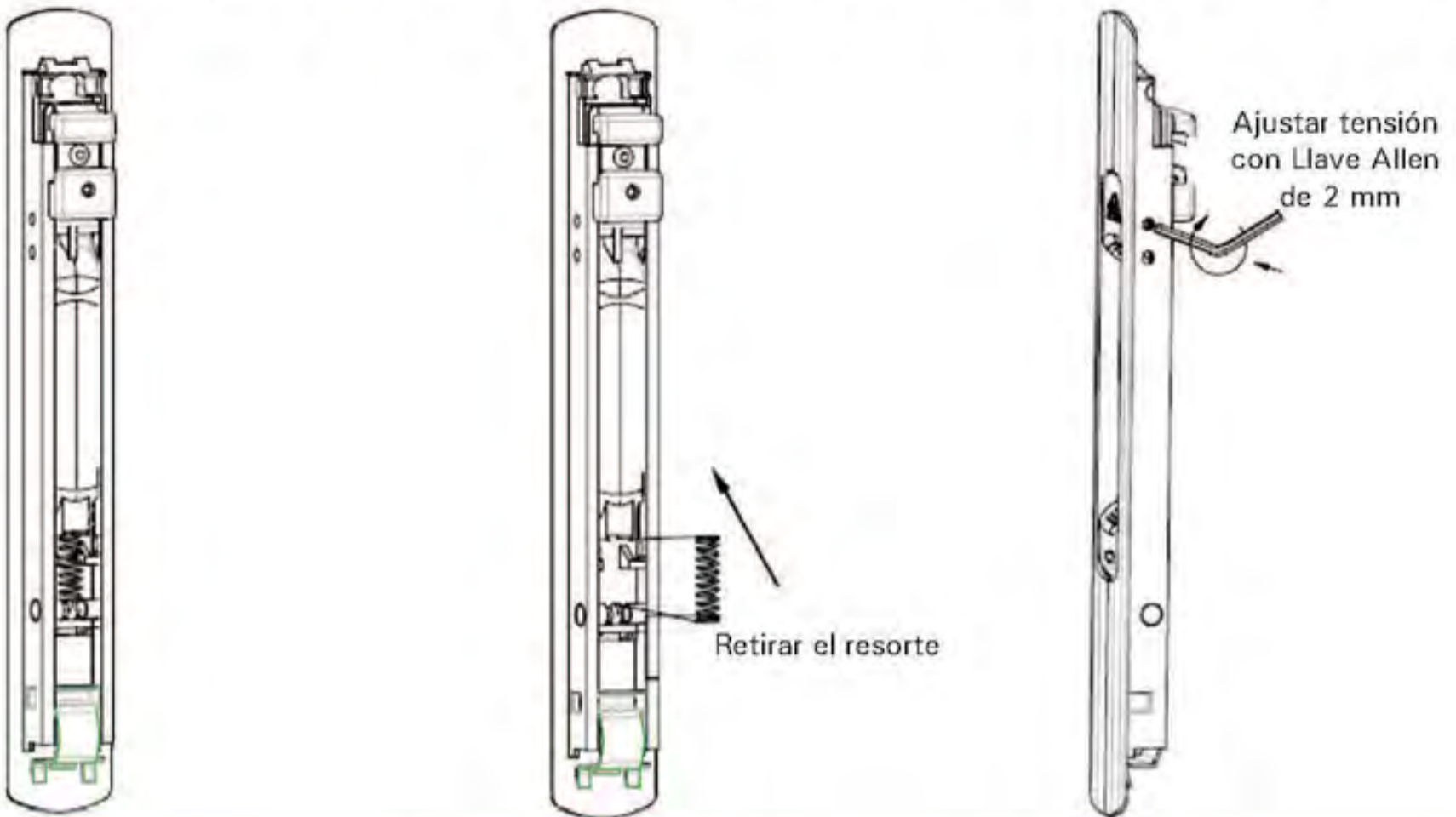

- Uñero DUO

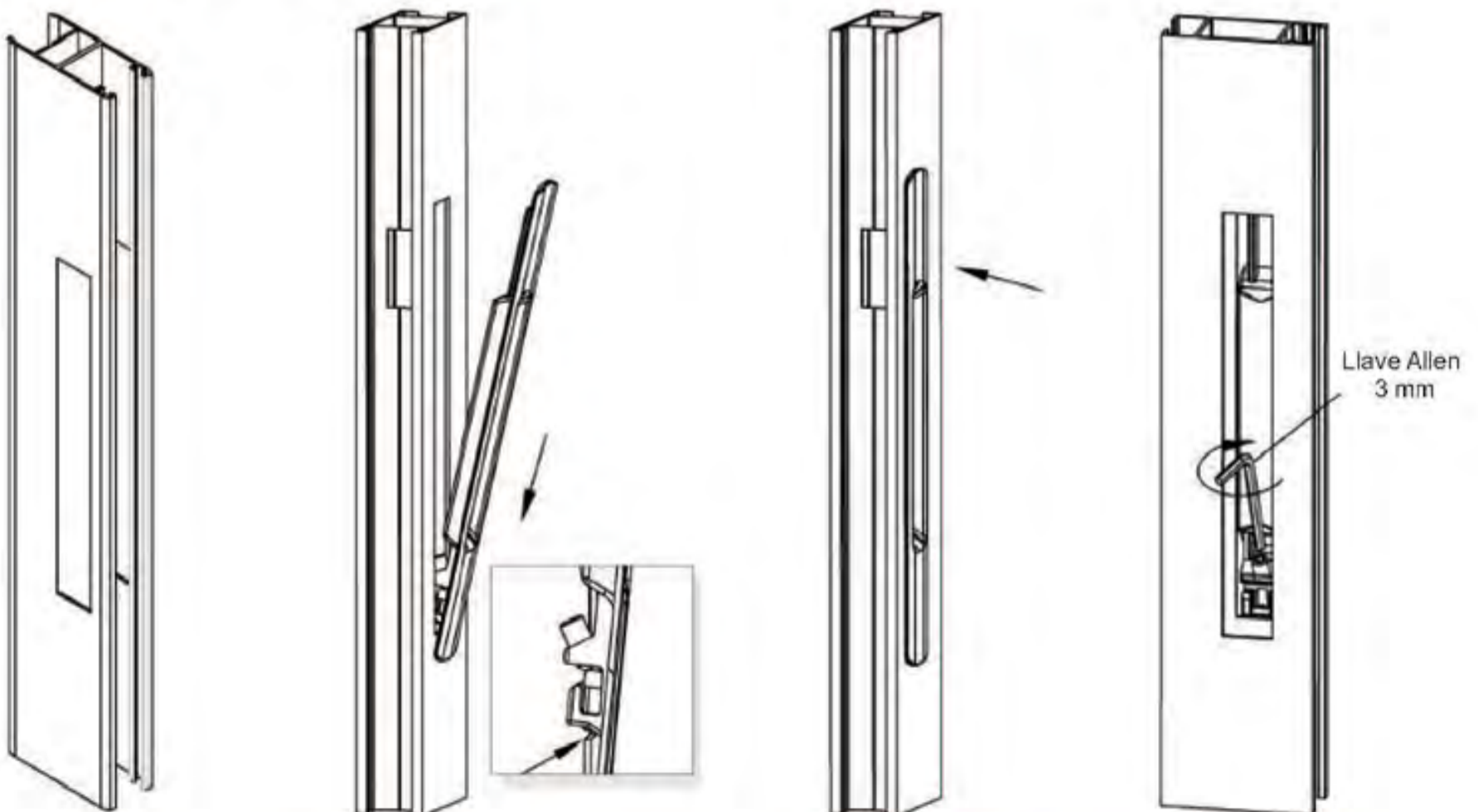

- Tirador DUO

Paso 1

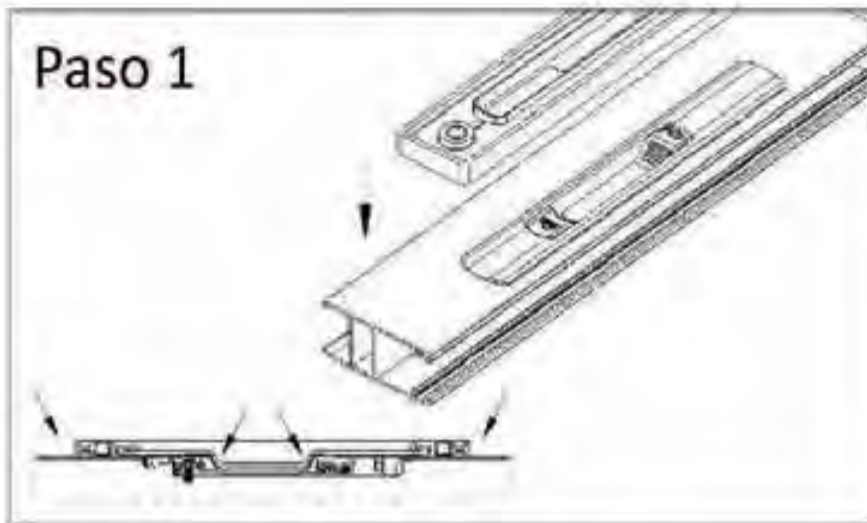

Paso 2

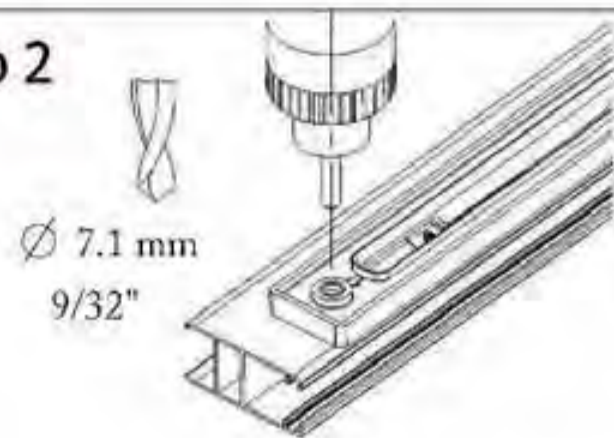

Paso 3

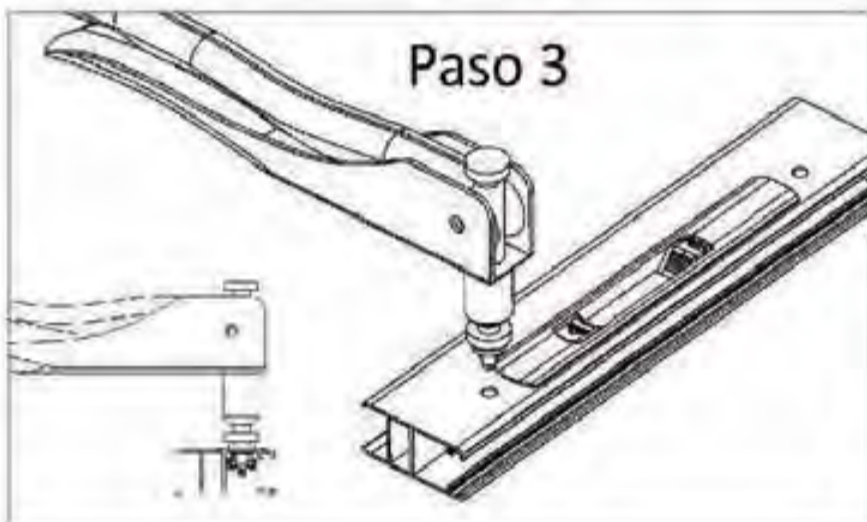

Paso 4

Llave Allen
3 mm

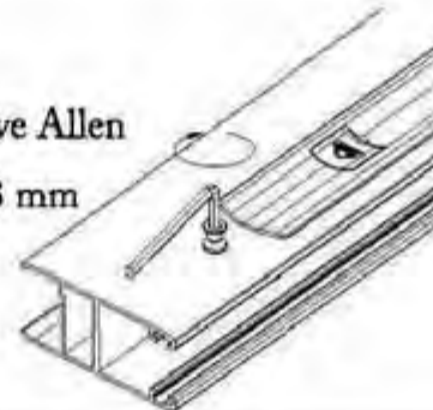

Paso 5

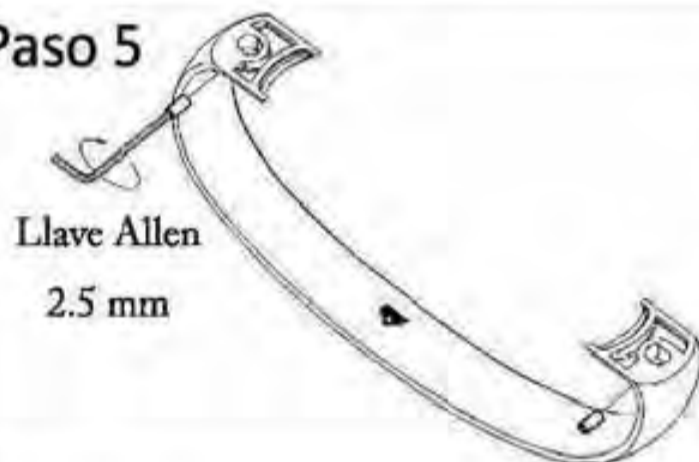

Paso 6

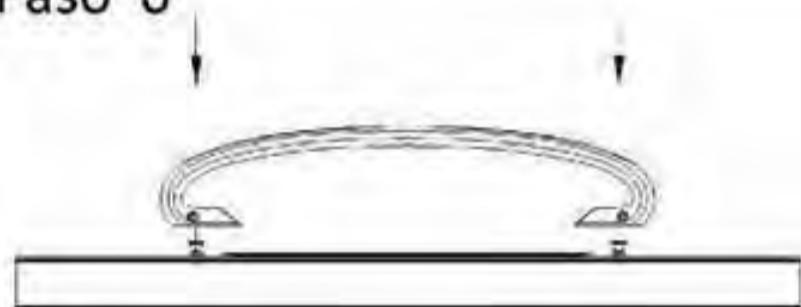

Paso 7

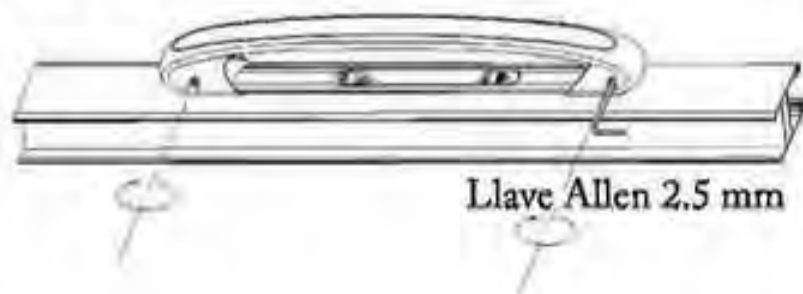

El Cierre multipunto

Hace la vida más fácil

- Diseño innovador
- Cerradero estrecho
- Cerradero con tope de goma



El calzo...



... es muy fácil de separar manualmente



Concepto de embalaje orientado al cliente

- ① Juego de calzos
- ② Kit de cerraderos
- ③ Cremona
- ④ Manilla

La regulación más fácil del mercado

Paso 1	Paso 2	Paso 3	Paso 4
<p>1. Inserte el calzo antes de montar los perfiles. Separe el calzo en la ubicación de la cremona</p>	<p>2. Instale la cremona y atorníllela.</p>	<p>3. Monte la manilla</p>	<p>4. Coloque la plantilla en la cremona</p>
Paso 5	Paso 6	Paso 7	Paso 8
<p>5. Coloque el calzo en el lado opuesto a la cremona, tal y como se muestra en la ilustración.</p>	<p>6. Marque una referencia sobre el marco. Fije el cerradero con un par de torsión recomendado de 1,5-2 Nm.</p>	<p>7. Enganche el tope de goma al cerradero.</p>	<p>8. Instale el tope de goma para correderas en la parte superior/inferior según los requisitos.</p>

CUPRUM SERIE 80

CÓDIGO	COLOR	MANILLA	CREMONA	PERFIL
MP802PW MP802PCH MP802PMA MP802PBE MP802PBR MP802PE4	Blanco Titán Marrón Beige Bronce Negro	 SENCILLA	 DOS PUNTOS	
MP802PLLCH MP802PLLMA MP802PLLW	Titán Marrón Blanco	 LLAVE		
MP804PW MP804PCH MP804PMA MP804PBE MP804PBR MP804PE4	Blanco Titán Marrón Beige Bronce Negro	 SENCILLA	 CUATRO PUNTOS	
MP804PLLCH MP804PLLMA MP804PLLW	Titán Marrón Blanco	 LLAVE		

CUPRUM SERIE 150

CÓDIGO	COLOR	MANILLA	CREMONA	PERFIL
MP1502PW MP1502PCH MP1502PMA MP1502PBE MP1502PBR MP1502PE4	Blanco Titán Marrón Beige Bronce Negro	 SENCILLA	 DOS PUNTOS	
MP1502PLLCH MP1502PLLMA MP1502PLLW	Titán Marrón Blanco	 LLAVE		
MP1504PW MP1504PCH MP1504PMA MP1504PBE MP1504PBR MP1504PE4	Blanco Titán Marrón Beige Bronce Negro	 SENCILLA	 CUATRO PUNTOS	
MP1504PLLCH MP1504PLLMA MP1504PLLW	Titán Marrón Blanco	 LLAVE		

CUPRUM SERIE 70 / SERIE 100

CÓDIGO	COLOR	MANILLA	CREMONA	PERFIL
MP712PW MP712PCH MP712PMA MP712PBE MP712PBR MP712PE4	Blanco Titán Marrón Beige Bronce Negro	 SENCILLA	 DOS PUNTOS	 S-70 S-100
MP712PLLCH MP712PLLMA MP712PLLW	Titán Marrón Blanco	 LLAVE		

INDALUM SERIE 4000

CÓDIGO	COLOR	MANILLA	CREMONA	PERFIL
MP4M2PW MP4M2PCH MP4M2PMA MP4M2PBE MP4M2PBR MP4M2PE4	Blanco Titán Marrón Beige Bronce Negro	 SENCILLA	 DOS PUNTOS	
MP4M2PLLCH MP4M2PLLMA MP4M2PLLW	Titán Marrón Blanco	 LLAVE		
MP4M4PW MP4M4PCH MP4M4PMA MP4M4PBE MP4M4PBR MP4M4PE4	Blanco Titán Marrón Beige Bronce Negro	 SENCILLA	 CUATRO PUNTOS	
MP4M4PLLCH MP4M4PLLMA MP4M4PLLW	Titán Marrón Blanco	 LLAVE		

Tope de Goma



Accesorios Multipunto

Plantilla Multipunto
Clave
490501



INDALUM 4500 Y EXTRUSIONES METÁLICAS 10,000

CÓDIGO	COLOR	MANILLA	CREMONA	PERFIL
MP10M2PW MP10M2PCH MP10M2PMA MP10M2PBE MP10M2PBR MP10M2PE4	Blanco Titán Marrón Beige Bronce Negro	 SENCILLA	 DOS PUNTOS	
MP10M2PLLCH MP10M2PLLMA MP10M2PLLW	Titán Marrón Blanco	 LLAVE		
MP10M4PW MP10M4PN MP10M4PMA MP10M4PBE MP10M4PBR MP10M4PE4	Blanco Titán Marrón Beige Bronce Negro	 SENCILLA	 CUATRO PUNTOS	
MP10M4PCH MP10M4PMA MP10M4PW	Titán Marrón Blanco	 LLAVE		

EXTRUSIONES METÁLICAS 4600

CÓDIGO	COLOR	MANILLA	CREMONA	PERFIL
MP462PW MP462PCH MP462PMA MP462PBE MP462PBR MP462PE4	Blanco Titán Marrón Beige Bronce Negro	 SENCILLA	 DOS PUNTOS	
MP462PLLCH MP462PLLMA MP462PLLW	Titán Marrón Blanco	 LLAVE		
MP464PW MP464PCH MP464PMA MP464PBE MP464PBR MP464PE4	Blanco Titán Marrón Beige Bronce Negro	 SENCILLA	 CUATRO PUNTOS	
MP464PLLCH MP464PLLMA MP464PLLW	Titán Marrón Blanco	 LLAVE		

PROFILO SERIE RAGAZZA

CÓDIGO	COLOR	MANILLA	CREMONA	PERFIL
MPRM2PW MPRM2PCH MPRM2PMA MPRM2PBE MPRM2PBR MPRM2PE4	Blanco Titán Marrón Beige Bronce Negro	 SENCILLA	 DOS PUNTOS	
MPRM2PLLCH MPRM2PLLMA MPRM2PLLW	Titán Marrón Blanco	 LLAVE		
MPRM2PW MPRM2PCH MPRM2PMA MPRM2PBE MPRM2PBR MPRM2PE4	Blanco Titán Marrón Beige Bronce Negro	 SENCILLA	 CUATRO PUNTOS	
MPRM2PLLCH MPRM2PLLMA MPRM2PLLW	Titán Marrón Blanco	 LLAVE		

Ejemplo de partes de multipunto 2 puntos

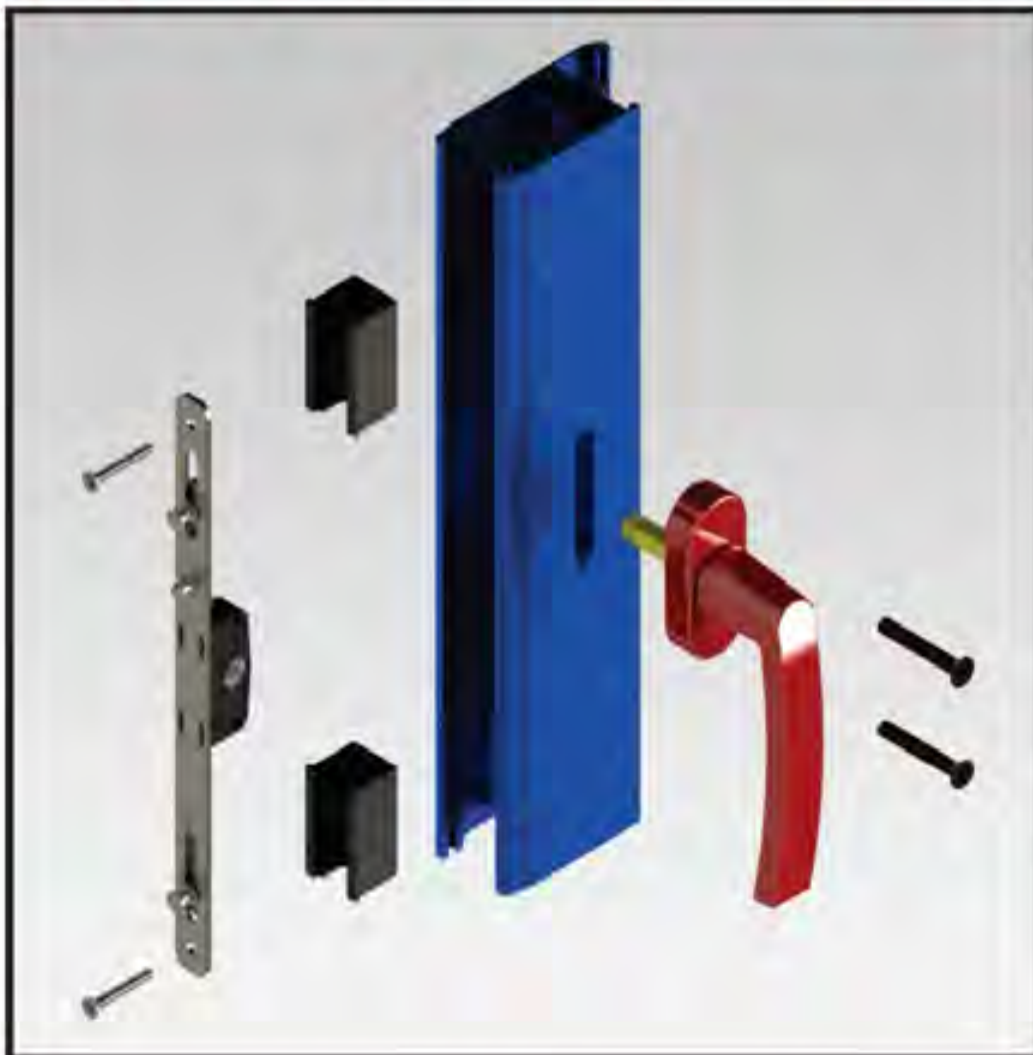

Manillas disponibles



Manilla Sencilla



Manilla con Llave



Pop up Sencilla



Pop up con Llave



Tirador Sencillo



Tirador con Llave

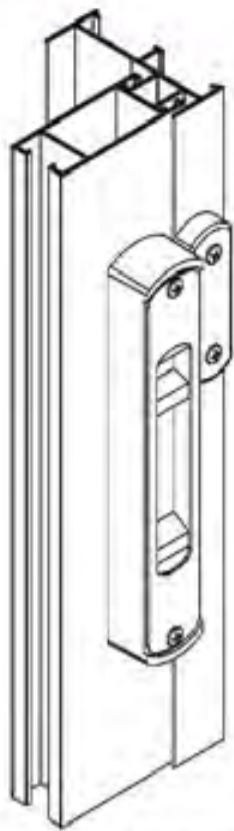

Jaladera de Sobreponer
Der. ó Izq. para 2" y 3"
Clave-1003

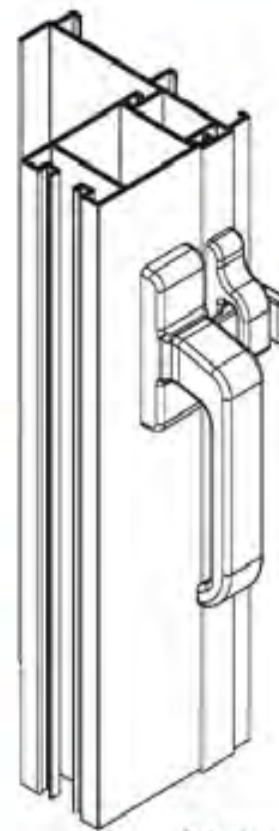
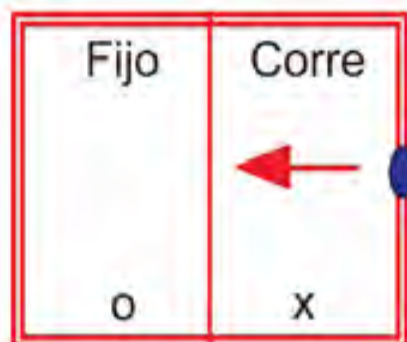

Jaladera Universal Tipo Española
para Corrediza ó Proyección
Clave-1033-U

N	NB	B	BB	ADK	E-5	E-1	E-2	W	E-4	H	BE	CA	CH	CHD	CHMTY
---	----	---	----	-----	-----	-----	-----	---	-----	---	----	----	----	-----	-------



Serie 50

Serie Ragazza

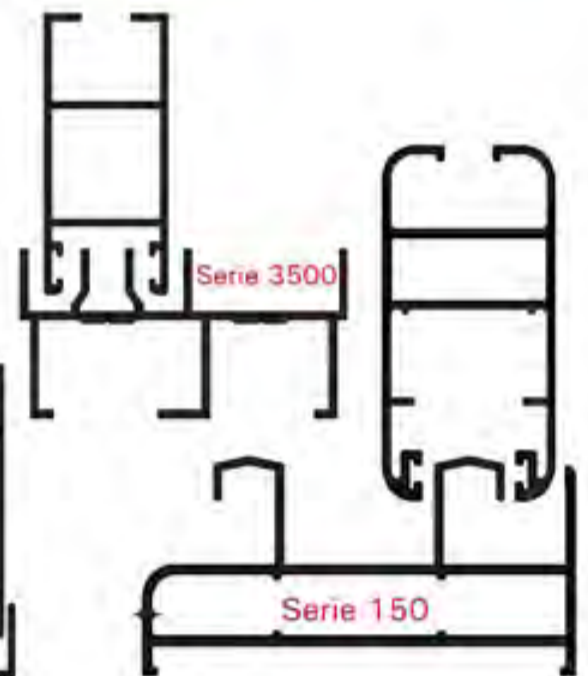

Serie 3500

Serie 150



Serie 70

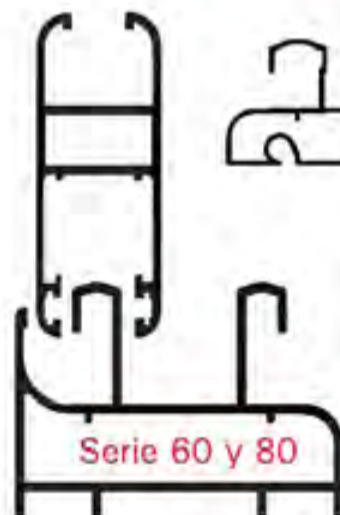

Serie 60 y 80



Serie 100

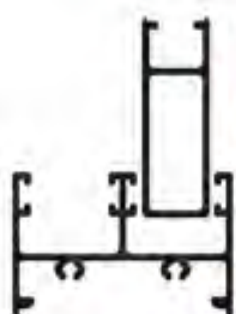

Líneas aplicables
para 2" y 3"

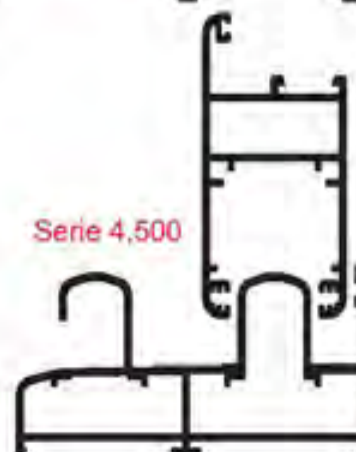
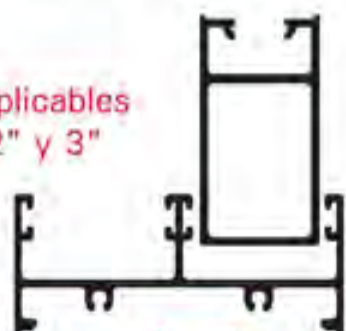

Serie 4,500

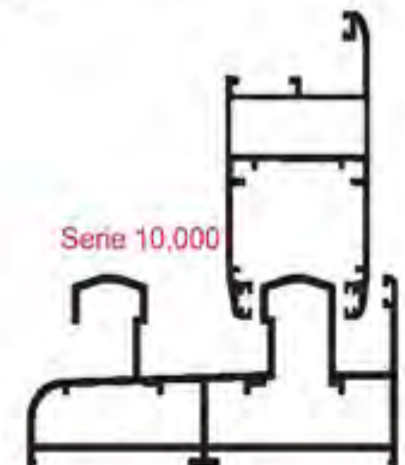

Serie 10,000

Seguridad

Cerrado

Abierto

Apertura Parcial Segura

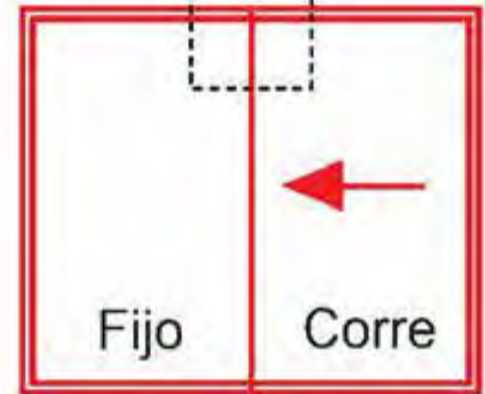
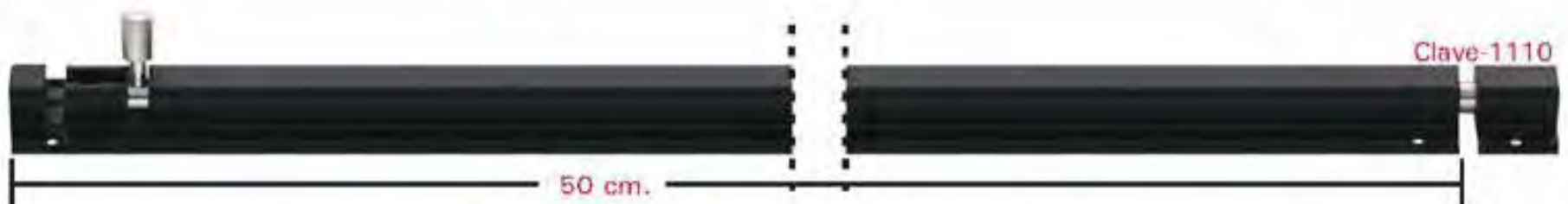

N	NB	O	B	BB	ADK	E-5	E-1	E-2	W	E-4	H	BE	CA	CH	CHD	CHMTY
---	----	---	---	----	-----	-----	-----	-----	---	-----	---	----	----	----	-----	-------

Seguridad

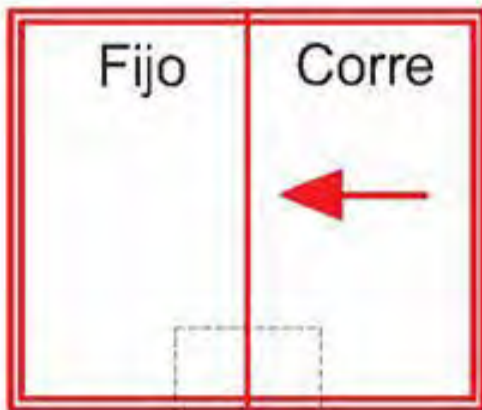

Seguro Para Puerta
Corrediza Con Perno de Acero
Clave- 042



Posición desbloqueada



Preparación para bloquear



Bloqueado

CHAPAS



Chapa Tetra
Gancho
Clave- 1411



Chapa Hérculite
Paleta ó Gancho
Clave- 1414



Seguridad

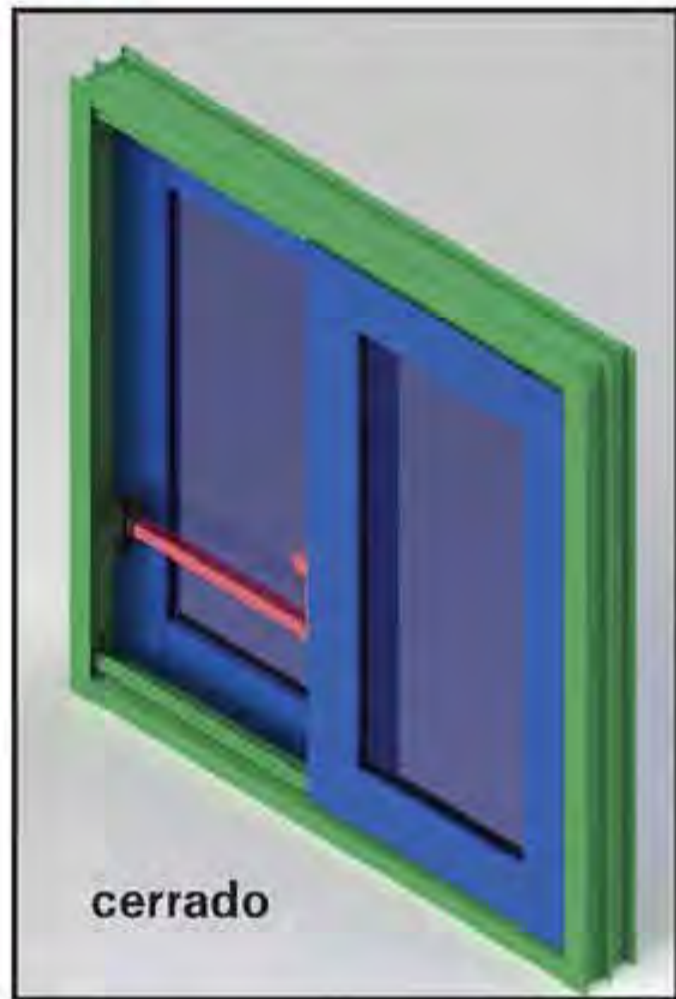
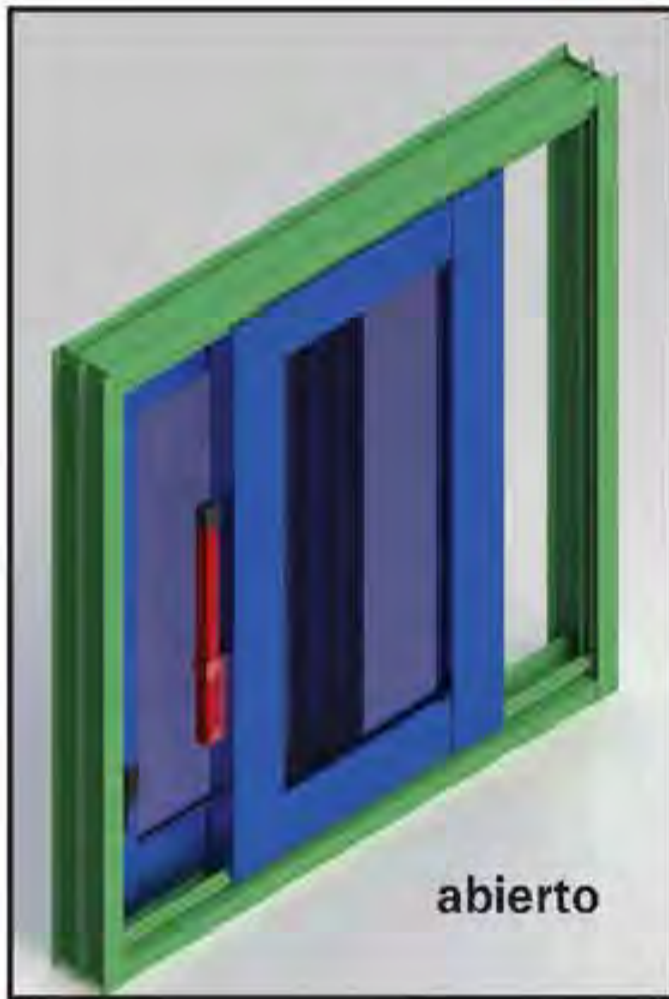

Medida Máxima 122 cm. (ajustable)

Barra de Seguridad para
Puerta y Ventana Corrediza
Clave- 043

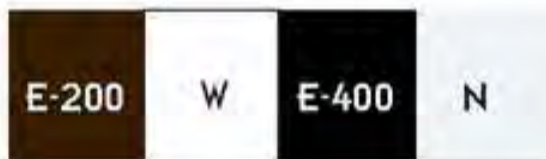

Tapa Traslape
Clave
5008

Clave	Riel
5008 PP	
5008 PC	
5008 GP	
5008 GC	

CANDADOS



Escuadra Línea 100
Aluminio
Clave- 507



Candado Línea 100
Clave- 514



Felpón
Línea 100 Montecarlo
Clave- 512



Tapa Línea 100
Gde.
Clave- 520

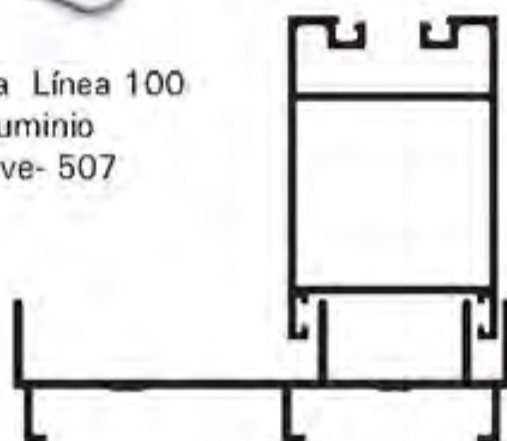

Sello
Línea 100 Gde.
Clave- 506

Tapa Línea 100
Ch.
Clave- 519

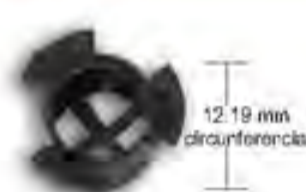

Dren Universal Nylon
Clave- 2132

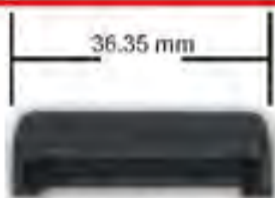

Desague Universal
Nylon
Clave- 2133

DRENES

Todas las líneas



Dren ALUBIN
clave-5003E4

SELLOS



Sello Pícola
Clave- 505



Candado Tope
y Guía línea Pícola
Clave- 502

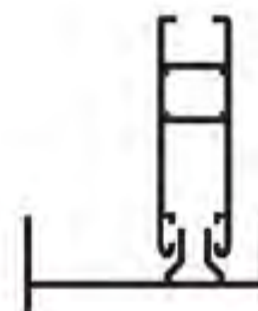

TAPA Y CANDADO



Tapa
S-4000 S-80
Clave- 2131



Candado Euroalum
S-4000 Y S-80
Clave- 2130

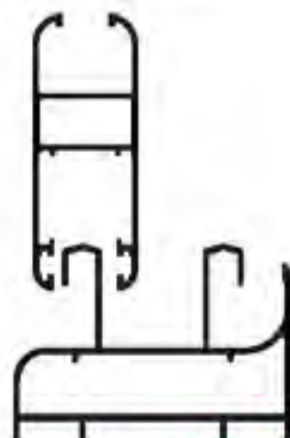
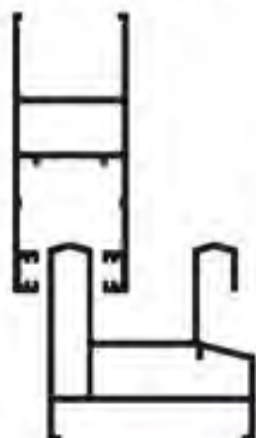

Troquel

Escuadra Cancel Baño
* Escuadra s/35 s/venas
* Escuadra Hoja Bicentenario
Clave- 1



Escuadras Finestras
* 4600 Extrusiones
* Bicentenario 602
Clave- 2

Resaque Jaladera 800
Línea Bicentenario
Clave- 3

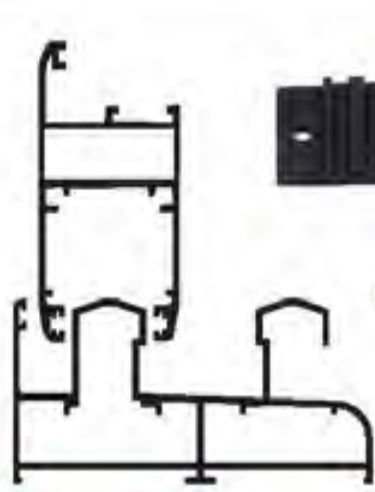

Felpón
Clave- 512

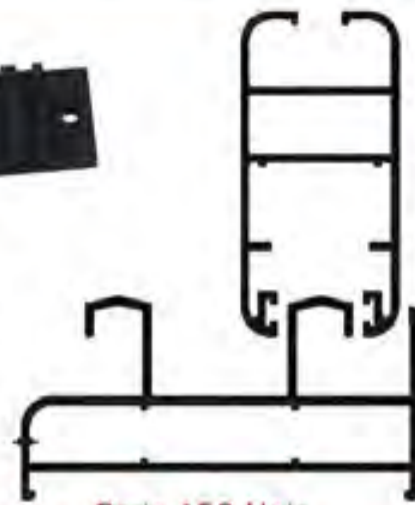

Escuadra Línea
10,000 y otras
Clave- 526

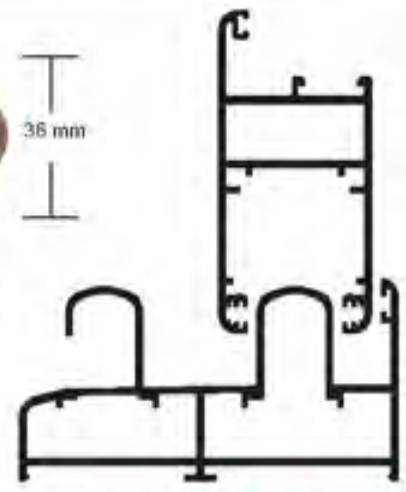

38 mm

Serie 4,500 Hoja

Serie 10,000 Hoja

Serie 150 Hoja

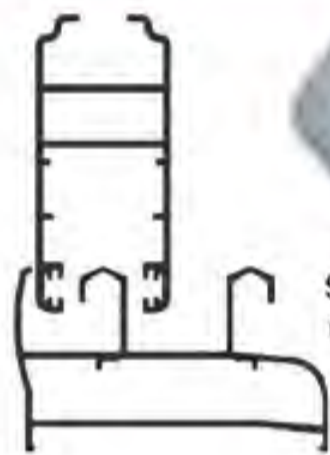

Escuadra
S-4600 Fijo
Clave- 601



Escuadra
S-4600 Hoja
Clave- 600



Escuadra S-4600
3 Rieles
Clave- 602

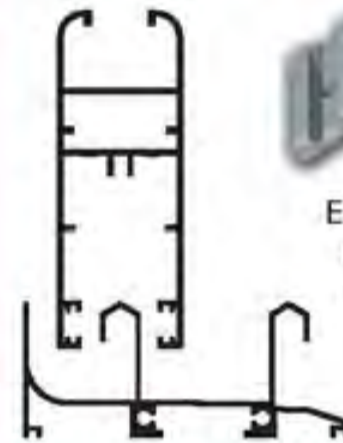

Escuadra Para
Bicentenario
Clave- 605

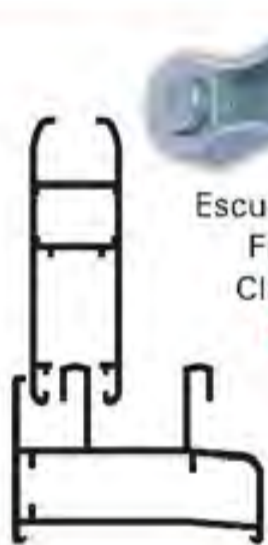

Escuadra Línea
Finestra
Clave- 517
Hoja



Escuadra Ventana 1400
Clave- 523
Riel



Escuadra Para
Finestra
Clave- 603
Hoja



Escuadra
Universal
Clave- 518

Hoja y Riel S-4000



Escuadra Línea
10,000 y otras
Clave- 526

Riel S-80



Escuadra de Alineación
Aluminio
Clave- 503 AL



Escuadra de Alineación
inoxidable
Clave- 503 IN



Escuadra de Alineación
Nylon
Clave- 503 NY

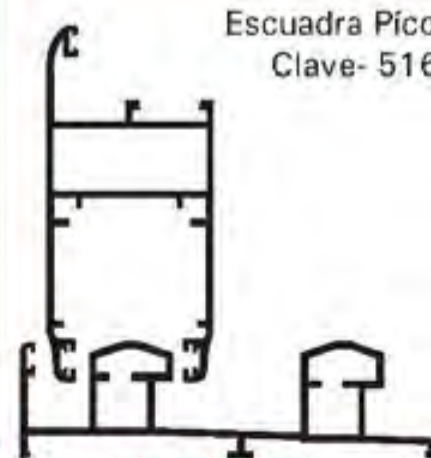

Escuadra Pícola
Clave- 516

S-10,000 Riel

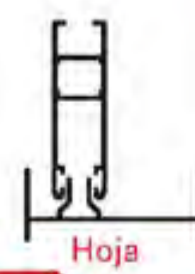

Hoja

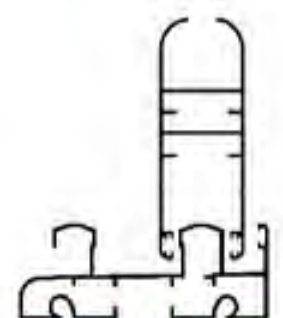

S-Ragazza Riel



Kit 10,000
Clave- 703

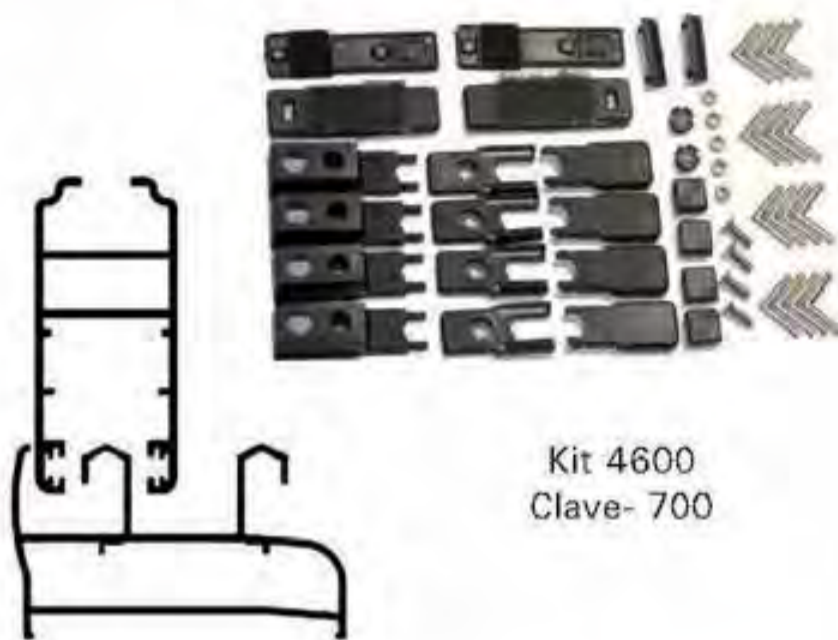

Kit 4600
Clave- 700



Kit
Bicentenario
Clave- 702

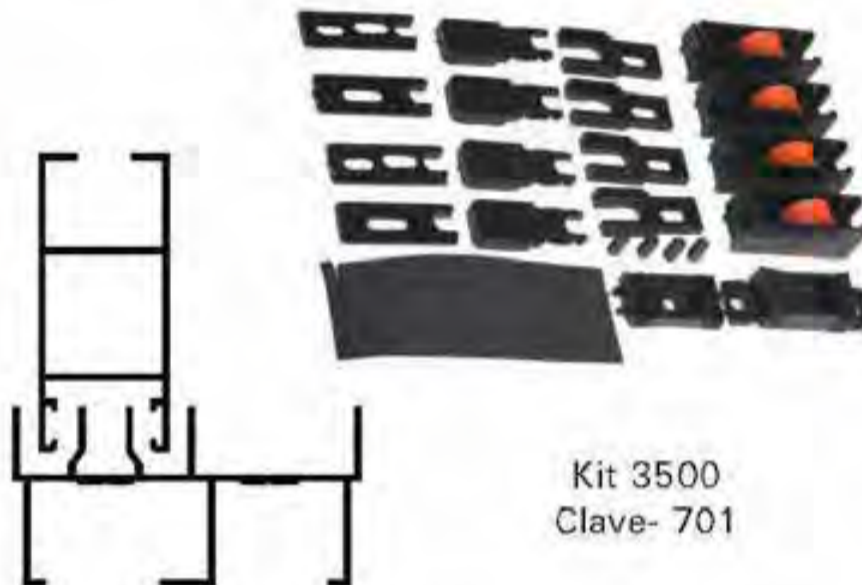

Kit 3500
Clave- 701



Kit
Finestra
Clave- 704

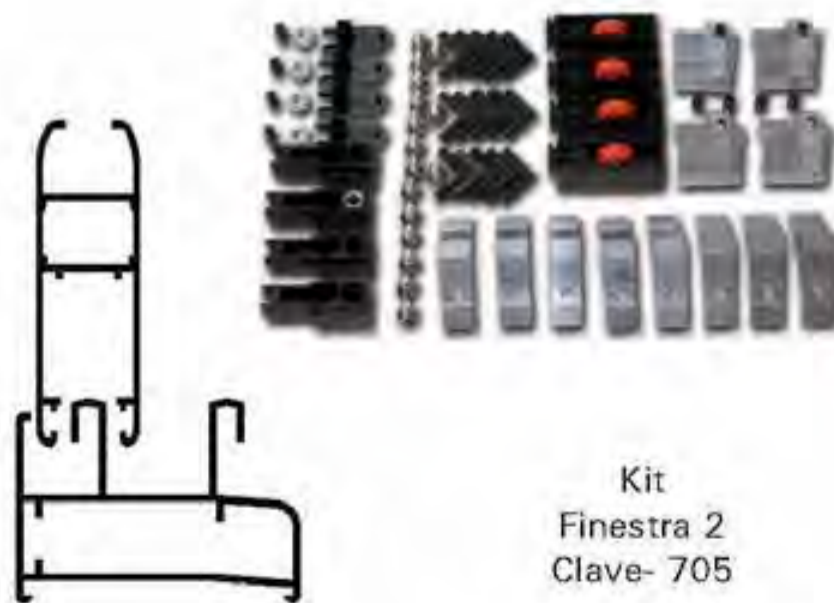

Kit
Finestra 2
Clave- 705

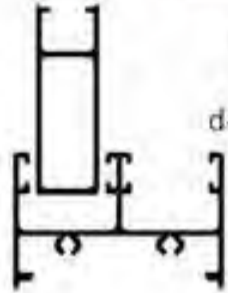

Carretilla Gorra de Napoleón Puerta 2" de Aluminio con Balero de Presición Plus Clave-1071

Balero Sellado de Presición

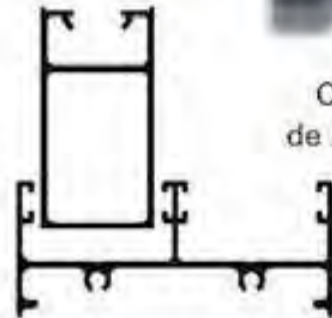

Carretilla Fija de 3" de Aluminio con Balero de Presición Plus Clave-1065

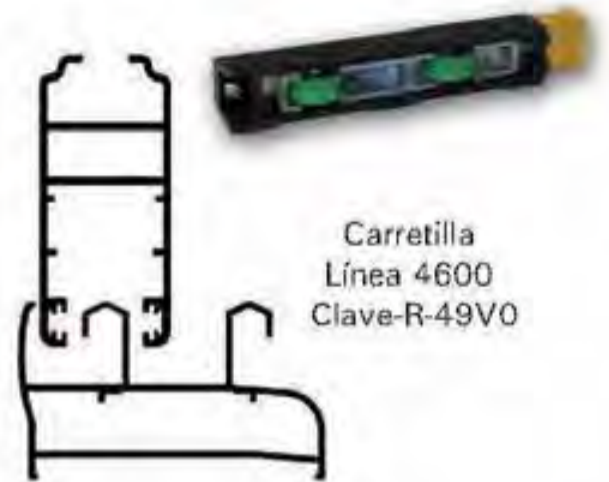

Carretilla Línea 4600 Clave-R-49V0

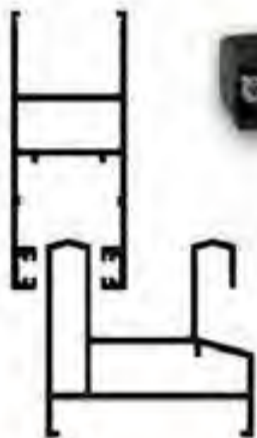

Carretilla Euroalum 4000 Clave-R-40N0

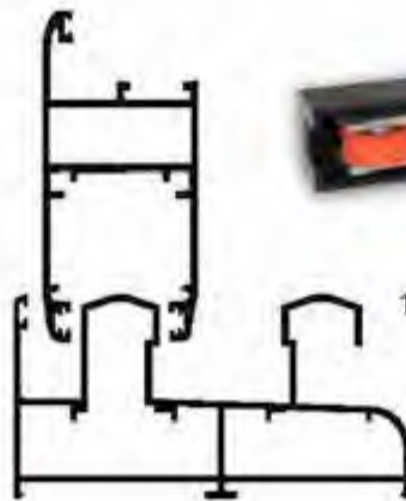

Carretilla 10,000 de Nylon Clave-7124



Carretilla Ajustable Balero de Aguja Para Serie 10,000 Clave - R1000

California



Carretilla Tipo California Clave-1047

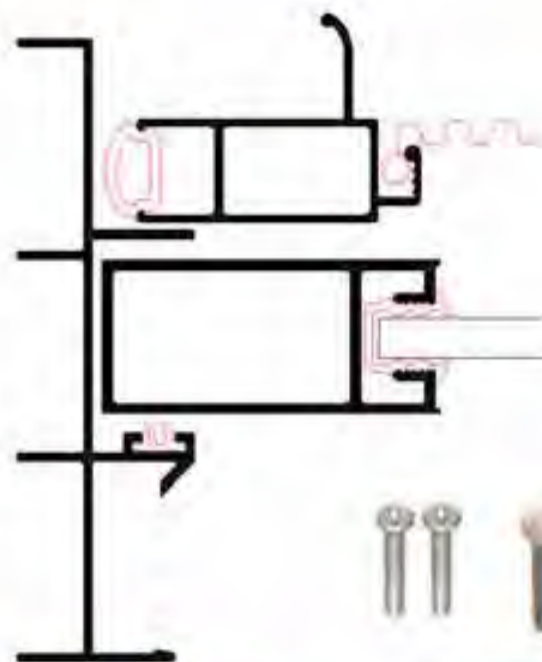

Jaladera California de 5" o 7" Clave-1039



Jaladera de
Embutir sin
Barrenos
Clave-800 CA



Jaladera Tirador de
Aluminio Solido de
Una Sola Pieza
Clave-1021 CA



Jaladera de Embutir
2" y 3"
Clave:
1001 Manual CA
1002 Automática CA



Jaladera Estriada
Clave:
1035-12cm. CA
1036-18cm. CA



Jaladera de Embutir 2"
Clave:
2011M-Manual CA
2011A-Automática CA



Jaladera Contra
Plana de 12 cm.
Clave- 1040 CA



Jaladera de
Sobreponer
Clave- 1003 CA



Jaladera Contra
Plana de 18cm.
Clave- 1041 CA



Uñero de Embutir
Tipo Español
de Aluminio
Clave- 1006 CA



Jaladera Trompa
de Elefante
Clave- 1042 CA



Uñero de Sobreponer
Tipo Español
de Aluminio
Clave- 1008 CA



**Pasador de Lujo
Especial de Aluminio**

- Clave- 1104 CA de 4.5 c.m.
- Clave- 1105 CA de 7.5 c.m.
- Clave- 1106 CA de 10 c.m.
- Clave- 1107 CA de 15 c.m.
- Clave- 1108 CA de 30 c.m.
- Clave- 1110 CA de 50 c.m.



TIRADOR CON LLAVE



Clave - 553031

E-4	H	BE	CA	CH	CHD	CHMTY
N	B	ADK	E-5	E-1	E-2	W

EMBUTIDA CON CHAPA PARA INSTALAR CON MOSQUITERO



Inox 323287	E-200 323283
	Blanco 323282

Cremona con Llave 4 pts.
Clave - 328994

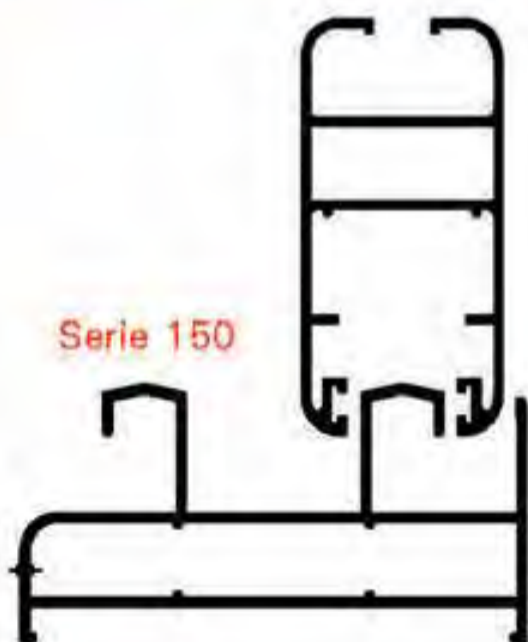

Serie 150

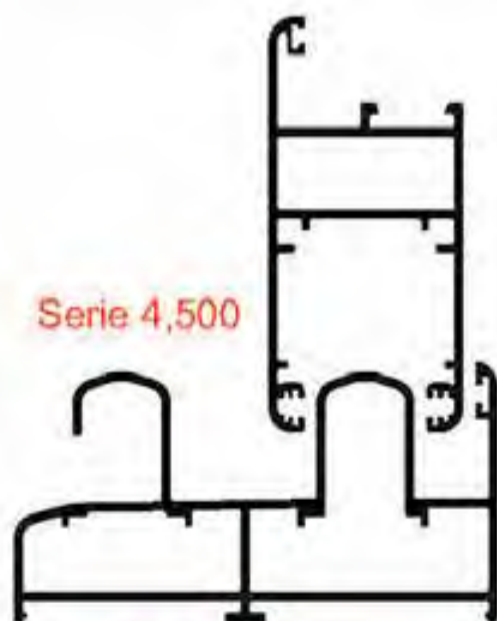

Serie 4,500

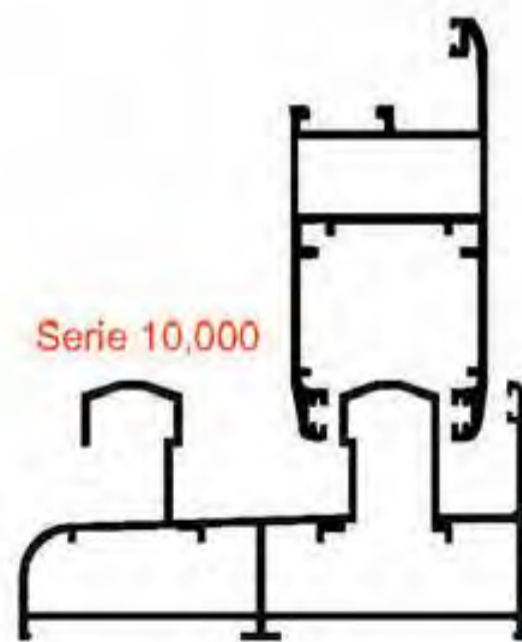

Serie 10,000

4 puntos





inman

Fabricantes de Herrajes Finos para Aluminio

